

# Writing in Multimodal Texts

## A Social Semiotic Account of Designs for Learning

Jeff Bezemer

Gunther Kress

*Institute of Education, Centre for Multimodal Research*

Frequently writing is now no longer the central mode of representation in learning materials—textbooks, Web-based resources, teacher-produced materials. Still (as well as moving) images are increasingly prominent as carriers of meaning. Uses and forms of writing have undergone profound changes over the last decades, which calls for a social, pedagogical, and semiotic explanation. Two trends mark that history. The digital media, rather than the (text) book, are more and more the site of appearance and distribution of learning resources, and writing is being displaced by image as the central mode for representation. This poses sharp questions about present and future roles and forms of writing. For text, *design* and *principles of composition* move into the foreground. Here we sketch a social semiotic account that aims to elucidate such principles and permits consideration of their epistemological as well as social/pedagogic significance. Linking representation with social factors, we put forward terms to explore two issues: the principles underlying the design of multimodal ensembles and the potential epistemological and pedagogic effects of multimodal designs. Our investigation is set within a research project with a corpus of learning resources for secondary school in Science, Mathematics, and English from the 1930s, the 1980s, and from the first decade of the 21st century, as well as digitally represented and online learning resources from the year 2000 onward.

**Keywords:** *writing; multimodality; representation; communication; multimedia; curriculum; pedagogy; textbooks; learning; learning resources*

---

**Authors' Note:** This article draws on an ongoing research project, "Gains and Losses: Changes in Representation, Knowledge and Pedagogy in Learning Resources" (2007–2009), which is funded by the Economic and Social Research Council (RES-062-23-0224). We wish to give particular thanks to Charles Bazerman, Christina Haas and Greg Myers, whose extensive comments helped us refocus the initial draft in a most helpful way.

## Introduction: Retheorizing Text Making and, in the Process, Writing

For scholars interested in writing, developments in contemporary communication sharply pose questions about the present role and the likely future development of writing. For those interested in contemporary forms of texts, the questions posed are about *design*, that is, *principles of composition*. After a brief introduction, we sketch a framework of explanation to then move to analysis and discussion of specific examples. Our specific focus in this article is on writing within a broader interest in the relation between social environments and representation.

When we compare a textbook from 1935 with a contemporary one, we note that there tends to be less writing now than there had been, and the writing that there is differs from the writing of 40, 50, or 60 years ago, both syntactically and in its use. Although images were present on the pages of textbooks before, there are more images now; these images look and function differently from those found before. The page is used differently to the way it had been: Writing and image are combined in ways that could not have been conceived of in the 1930s. Curricular content is represented differently, and the manner in which curricular materials are laid out on the page points to a social and epistemological change that cannot be explained by a focus on representational practices alone. If, going one step further, we compare a contemporary textbook with “pages” on the Web dealing with the “same” issues, we see that modes of representation other than image and writing—moving image and speech for instance—have found their way into learning resources, with significant effect.

Divergent, contradictory, confusing views dominate debates on the effects of contemporary practices in representation; they tend to invoke practices of “the past.” The views range from cultural pessimism (Postman, 1993; Tuman, 1992) to concerns about economic performance, as witnessed in studies sponsored by the Organisation for Economic Cooperation and Development (OECD), such as the Programme for International Student Assessment (PISA), Trends in International Mathematics and Science Study (TIMSS), and Progress in International Reading Literacy Study (PIRLS). To the pessimists, the increasing use of image threatens literacy skills and must inevitably lead to the “dumbing down” not just of textbooks but of all of culture and, by a further effect, is bound to have deleterious effects on economic performance. Less prominent, if equally firmly expressed, are beliefs in the empowering potential of such changes. In reviewing major

contributions to the debate Kaplan (1995) found that rather than engaging in attempts to elucidate the effects of the distinctive affordances of different modes and media, the debate has focused on cultural ideals, while the social production of representation was ignored. We are keen to describe these affordances and to develop such means of elucidation.

There has been considerable research on representation in learning resources from diverse perspectives: Some has focused on comprehension or on the effect of image on students' memory or understanding of concepts (e.g., Martinez Pena & Gil Quilez, 2001; Pintó, 2002). Other studies have focused on the ways in which image is used by designers (Unsworth, 2001). Yet others (Dimopoulos, Koulaidis, & Sklaveniti, 2003; Pozzer & Roth, 2003; Roth, Bowen, & McGinn, 1999) have categorized images and counted occurrences in different textbooks, comparing the results with other media, including scientific journals and newspapers. In other studies, the affordances of electronic media have been the focus (Jewitt, 2003; Lemke, 2000).

Yet what is lacking so far is an account of the relation between the *make-up*, the *shape* of texts—the *designs* of learning resources—and their potentials for learning (Kress, 2005). In a current research project, we aim to provide such an account by looking at representational changes in learning resources between about 1930 and 2005. Our frame is a *social semiotic* theory, and we ask, “What exactly is the relation between the semiotic designs of *multimodal* learning resources and their potentials for learning?” We aim to show what changes in principles of designs of texts there have been and how the designers of learning resources—visual artists, editors, writers—have used and now use writing, image, layout, and other semiotic resources to create *potentials for learning*. By potentials for learning we mean the ensemble of semiotic features of a text or of an environment—objects, texts, people—that provides the ground for learning and in that way may shape what learning is and how it may take place. It includes the epistemological as well as the pedagogical significance of representational practice.

Explanations of forms and effects need attention to the social origins of texts as much as to their semiotic effects: attention to the potentials and constraints of modes as well as their interactions in learning resources—image, writing, moving image, speech—as well as attention to the potentials and constraints of media—the printed media, such as the textbook, or the electronic media, such as the Web.

To that end we put forward conceptual and analytical tools that we believe may illuminate principles of designs for representation and help us in understanding the present as much as the developing multimodal

representational world. Key concepts are *sign*, *mode*, *medium*, *frame*, and *site of display* (Halliday, 1994; Hodge & Kress, 1988; Jewitt, 2005; Kress et al., 2005; Kress, Jewitt, Ogborn, & Tsatsarelis, 2001; Kress & van Leeuwen, 2001, 2006). In the section titled “Three Examples of Transduction,” we focus on two processes of change to representations. One, *transformation*, involves changes within a mode; in the other, *transduction*, semiotic material is moved across modes, from one mode (or set of modes) to another mode (or set of modes). Media—the means for the distribution of messages—also have affordances, so that changes in media have social and epistemological effects. We include these in our discussion and in the theoretical framework we develop here, even though they are outside our focus.

By discussing examples from learning resources we show forms and changes and the epistemological and communicational effects produced in any changes. We ask what might be gained and what might be lost in changes of mode: from artefact and action to image, from image to writing, to speech, or to moving image. Bernstein’s (1996) notion of *recontextualization* is useful in two distinct and connected senses, socially and semiotically. The social perspective illuminates how *discourses* that originate outside education are realized in a manner apt for a specific pedagogic site, its audience and its purposes, to constitute the content of school subjects. *Originating* and *pedagogic* sites are defined here in terms of the social positions of the sign makers. Semiotically, this appears in terms of the modes and media typically involved, both in the originating site and in the site of recontextualization. Our examples permit us to show how *meaning material* is moved from social site to social site, from medium to medium, from context to context, in each case requiring social, semiotic remaking and often entailing epistemological change.

The *corpus* consists of multimodal, hyper- or interrelated “texts” (lessons, units, chapters, exercises from textbooks, workbooks, CD-ROMs, DVDs, Web sites) for the lower years (a chronological age of, broadly, 11 to 14 years) of secondary English (Language Arts), Science, and Mathematics in England, published between 1930 and 2005. Each of the subjects is represented via a topic that has been stable enough to remain in the syllabus in one form or another throughout the period we have chosen. The selection of stable topics is meant to allow us to capture some of the potential variability in designs within the subjects and over time. Within English, the focal topic is *simile*, within science, *digestion*, and within mathematics, it is *angles*. In this article we draw on four texts for each topic, one printed text for each “era” and one electronic text for the present era.

## Representation as Social and Semiotic Practice: Some Concepts

### Sign Makers and Signs

In a social semiotic account of meaning and meaning making, producers as well as users of learning resources—visual artists, editors, writers, teachers, and students—are regarded as meaning makers or *sign makers*. Signs are elements in which meaning and form have been brought together in a relation motivated by the interest of the sign maker. The process of sign making is always subject to the availability of semiotic resources and to the aptness of the resources to the meanings that the sign maker wishes to realize. In principle, limitations apply always and everywhere, even if not with the same severity: In many classrooms around the world there exist the severest constraints on resources both for teachers and children. Yet irrespective of these, the design of a learning resource is treated by us as the sign maker's apt representation of her or his interest.

### Interest

The interest of the producer of learning resources is twofold: rhetorical/pedagogical and epistemological. Pedagogical interest responds to the question, "How can I best realize my preferred social relation with the imagined audience?"; epistemological interest to the question, "How is subject content best realized while maximizing the learner's engagement?" The producer's as well as the audience's interests are shaped by the social, cultural, economic, political, and technological environments in which signs are made; the design is the result of the interaction between all of these. At the same time sign makers have to be aware of the media of distribution for their signs and that awareness is factored into the making of the sign.

### Meaning and Situated Use

A frequent objection made to this approach is that one cannot analyze representations by focusing on design(ers) and ignoring those who use them. That issue is complex. It asks whether texts carry meaning independent of their situated use—whether texts come "alive" only when they are brought into action and communication, by themselves and in interaction with others (cf. Baker & Freebody, 1989; Maybin & Moss, 1993). A first response on our part is that of course we can analyze representations as a formal exercise; a

second response is that here we are not focusing on use—our focus, rather, is on providing means for describing and understanding “what is being used.” But to go where the question is actually pointing, that is, whether one can make claims about *readings* and *effects* of representations without a study of their use, we would say, of course one cannot. One can however formulate hypotheses, more or less securely founded. We acknowledge the significance of studies of the situated use of texts and the production of users’ accounts of their usages of texts. These help to provide securer foundations. At the same time we consider texts to be *potentials* of a quite specific kind that in their specificity allow an unlimited (in number) yet constrained (in semantic scope) number of readings. These potentials can be understood as the sign makers’ shaping of signs such that the text-as-complex-sign fits the purposes of a rhetor (who frequently is also the designer), the designer, and their sense of the audience. The aim of our approach is to draw attention to the potentials and constraints of the “stuff” that is being used, to the agency of sign makers and to the significance of all actions in the process of sign making.

## Modes

A *mode* is a socially and culturally shaped resource for making meaning. Image, writing, layout, speech, moving image are examples of modes, all used in learning resources. Meanings are made in a variety of modes and always with more than one mode. Modes have differing *modal resources*. Writing, for instance, has syntactic, grammatical, and lexical resources, graphic resources such as font type, size, and resources for “framing,” such as punctuation. Writing might make use of other resources, for instance, the resource of color. Speech and writing share aspects of grammar, syntax, and lexis. Beyond these, speech has intensity (loudness), pitch and pitch variation (intonation), tonal/vocal quality, length, silence. Image has resources such as position of elements in a framed space, size, color, shape, icons of various kinds—lines, circles—as well as resources such as spatial relation, and in the case of moving images, the temporal succession of images, *movement*.

These differences in resources mean that modes can be used to do different kinds of semiotic work or to do broadly similar semiotic work with different resources in different ways. That is, modes have different *affordances*—potentials and constraints for making meaning. This enables sign makers to do different work in relation to their interests and their rhetorical intentions for designs of meaning, which, in modal ensembles, best meet the rhetor’s interest and sense of the needs of the audience. That is, by drawing on the specific

affordances of different modes in the making of complex signs as modal ensembles, sign makers can meet the complex, often contradictory demands of their own interest, the needs of the matter to be communicated, and the characteristics of the audience.

*Mode, community, and convention.* In social semiotics, what is to count as mode is treated as a matter for decision by communities and their social-representational needs. For the “ordinary” user of the mode of writing, *font* is part of that mode. For a typesetter or graphic designer, the meaning potentials—the affordances—of font are such that it can be used as mode; that is, meaning can be made through the affordances of font. What counts as mode depends on sign makers acting within the needs and understanding of a particular community and its more or less conventionalized practices.

## Medium

Mode and modal uses have to be considered together with the *medium* of distribution involved in communication. Medium has a material and a social aspect. Materially, medium is the substance in and through which meaning is instantiated/realized and through which meaning becomes available to others (cf. “oil on canvas”). From that perspective, print (as paper-and-print) is medium; by extension, the book is medium, if differently, the screen another; and the “speaker-as-body-and-voice” yet another. The contemporary situation with respect to media may be more complicated than it had been hitherto. In the “new media,” the range of different technological devices that operate in a chain of materialization processes are largely invisible to the lay person. So at the end of one chain are, for example, the computer-screen-and-speakers, prior to that are CD-ROM, CD-ROM-player, computer processor, and so on; all play a specific part in the chain of materializing and rematerializing.

Socially, medium is (the result of) semiotic, sociocultural, and technological practices (cf. film, newspaper, billboard, radio, television, theater, a classroom, and so on). From this perspective, textbook is one medium and Web-based learning resources for students are (becoming) another. There are now a range of Web sites funded by public and private organizations—Intel, BBC, Heinemann—that provide resources for primary and secondary school students in England and that, like their textbook counterparts, are organized along the lines of the (English) “National Curriculum.” The expansion of Web-based resources, some freely available, may well lead to a decline in the use of the medium of the textbook. The consequences will

be far reaching: semiotically, for instance, in changes to the uses, forms, and valuations of the mode of writing, socially through the potentials for semiotic action by sign makers. Such changes in media are always subject to social contestation. As one current example, walls and other surfaces (e.g., [underground] trains) are transformed into medium by graffiti artists.

### Site of Display

If we take a sheet of A4 paper, we can write an announcement on it and pin it on a wall; we have created a poster. We can also fold it, write an announcement on the front page, and fill the other three pages with a diverse range of information: We have created a booklet. We can also fold it twice, cut it in four pieces, and write an announcement on all four parts: We have created flyers. In all three instances we have reshaped the material medium of paper to create a *site of display* that is apt for our interests. It is the space that becomes available as medium for the display of text as complex sign.

### Frame and Genre

As we were creating different sites of display, we did not change the social *frame*: In all instances we used the same “basic framework[s] of understanding available in our society for making sense” (Goffman, 1986, p. 10): We made an announcement. Goffman’s quote focuses on social frames—*events*. If we replace his social category of event with the semiotic category of *genre*, then kinds of frames in a textbook could be *example, exercise, summary, demonstration*. Genres are the semiotic obverse of the social event. They are realized at the textual level; every text has a generic form. Each of these frames/genres defines text in terms of activity, of social relations of participants in an event, and in terms of the use of modes and media. Frames operate at any level: Whatever the semiotic entity is, it requires a frame.

*Frames and sites of display.* In looking at representational changes in learning materials we need to understand how frames relate to sites of display. How does a frame like announcement map onto a site of display? Does an expose map onto a chapter? Does an index map onto the banner of a Web page? The significance of these issues in design become noticeable where they appear to misfire: one announcement using two posters, one expose using two-and-a-half chapters, an index requiring scrolling down to



get to the lines beyond the lower edge of the screen. As frames change, new sites of display are created. In the 1930s textbook, for instance, the chapter was the site of display of a coherent, integral unit of knowledge (e.g., an expose on the human digestive system); now, in the contemporary textbook, the double-page spread is used as a site of display for a unit of work (a lesson, a demonstration). Both kinds of sites are afforded by the medium of “the book,” but by a notion of book that has changed radically over that 70-year period. As a site of display, a chapter is entirely different from a double page spread: The chapter is organized first and foremost as a conceptual, epistemological site; the double page spread is organized first and foremost as a material and semiotic site.

*Site of display and content.* The size of a chapter was determined by the author’s sense of the “completeness” and of “justice to the subject matter”; by contrast, it is the space of the double-page spread that shapes what content will appear and how. Of course, both the older and the newer textbook were linked more or less closely into other units and notions: to a curriculum, for instance, and its syllabus, to organization of teaching, such as number and length of lessons. Representation responds to social factors via diverse cultural and semiotic resources. Among others, this raises the question of what the medium of book had been, is, and is likely to become in its interrelation with the rapidly changing “screen.” This question applies to all media and to all modes.

## Design

Given the complex relation of modal affordance, rhetor’s interest and the variability and complexity of social environments, *design* moves into the centre of attention in the making of complex signs-as-texts. The shift, conceptually, from *composition* to *design* mirrors a social shift from competence in a specific practice conceived in terms of understanding of and adherence to convention governing the use of a mode—writing, say—to a focus on the interest and agency of the designer in the making of signs-as-texts. Design is the practice where modes, media, frames, and sites of display on the one hand, and rhetorical purposes, the designer’s interests, and the characteristics of the audience on the other are brought into coherence with each other. From the designer’s perspective, design is the (intermediary) process of giving shape to the interests, purposes, and intentions of the rhetor in relation to the semiotic resources available for realizing/materializing these purposes as apt material, complex signs, texts for the assumed characteristics of a specific audience.

## Transduction: Changing Modes and Media

In representing the world, *translations* are constantly made of meanings made in one mode or ensemble of modes to meanings made in another mode or ensembles of modes. Such translations are inevitable because, on the one hand, social environments are changed in recontextualization, and on the other hand, the available modes and media and their affordances are constrained. Our socially/rhetorically oriented theory of meaning (making) suggests that the choices for translation into particular ensembles of modes is motivated by social, pedagogic, and epistemological concerns. An object, such as a protractor, can be drawn into interactions in which participants and material objects are physically copresent, for example in the office of an architect or in a classroom. In both cases the object is present, available as an element in a mode of entities. In a textbook, that object-artefact is not available as a mode. The protractor and its use, involving gesture, body posture, gaze, relations to other material objects, and so on, now has to be “described” (translated) using image, writing, and perhaps other modes, as well as a specific medium. (In our framework we use *translation* as the general semiotic term and *transduction* as the more specific term when we speak of the move of semiotic material from one mode to another.)

Modes have different materiality and it, shaped by the histories of cultural work, has produced the specific affordances of a mode. Given that difference in material and cultural work, there can never be a perfect translation from one mode to another: Image does not have “word,” just as writing does not have “depiction”; forms of arrangement (i.e., syntax) differ in modes that are temporally or spatially instantiated. Transduction inevitably brings profound changes in the move from one mode to the other. In such contexts we can ask about gains and losses in the process of modal change.

While transduction describes changes involving a change in mode, *transformation* describes changes in arrangement within one mode. Theoretically, transformations are operations on structures within the one mode in which entities remain the same while structures change. In a transformation, say within the mode of writing, words remain, syntactic/grammatical categories remain those of the mode, as do textual arrangements. What changes is their arrangement. In transduction, the change from one mode to another brings with it a change of entities. There are no words in image, there are depictions; semiotic/semantic relations that, in speech or writing, are expressed in clauses and as verbs are realized through *vectors* or lines. Other semiotic relations between lexical-syntactic elements—prepositions, for instance (on, over, by, etc.)—are realized by spatial means in images, and so on.

As a matter of course, the new media demand facility in design practices of a high level, namely the ability to “move” the *semiotic material* or *content* of a textual entity from one mode or modal ensemble to another. For instance, in translating a novel to a CD-ROM (Jewitt, 2003) a whole range of rhetorical and design decisions have to be made. Characters that, in the novel-as-book, “exist” in the mode of writing can now appear in the mode of image, with all the potentials and constraints—and necessary transductions—involved in that. Assume two characters appeared in the novel-as-book. The author might have given a written description like, “Sitting in the late autumn sunshine, Sam and Bill share a bench in the park”. An illustrator or designer might have been asked to “draw across,” to *transduct*, the written description into the mode of image. Now the illustrator has to ask “How close to each other were they sitting?”; “Was Bill to the left or to the right of Sam?” The translator/transductor has to become precise, whether she or he wishes to do so or not. In an image-representation the distance between the two characters has to be shown; one cannot do otherwise. Elsewhere (Kress, 2003) this is called *epistemological commitment*. An epistemological commitment is an unavoidable affordance: In the visual mode the designer *has* to show the distance between the two characters. Every mode imposes/demands such commitments as a matter of course, though each such set of commitments is different. That has to be part of the designer’s consideration.

Practices of moving semiotic material are not novel, nor are they in any way exclusive to educational environments (cf. Lemke, 2000; Myers, 1990; O’Halloran, 2005, for examples of transduction in science). Transduction is a part of human semiosis and has been as far back as there are records such as sculptures, paintings, carvings in caves, on rock faces, in sites of ancient habitation. But in the time scales of cultural histories of (Western) representation the present may be distinctive through the ubiquity, the “intensity,” and the centrality of the process. The new media have made available new kinds of modal ensembles to very many users, offering possibilities of representation that had not existed before, or if so, then rarely (e.g., the opera). The CD-ROM can bring together not just writing and image, as in this example, but writing, moving image, speech, still image, music, soundtrack, and so on, and such ensembles offer possibilities for representation that are different from an ensemble of still image and writing or of writing alone. The existence of such wide and diverse representational possibilities, of course, simply demands engagement with and facility in design.

**Figure 1**  
**Excerpt From *Impact Maths 1G***

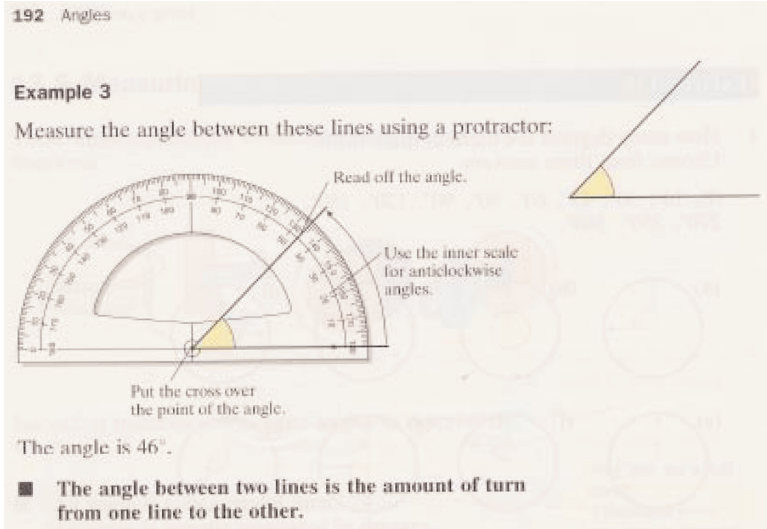

Source: Cole et al. (1999), p. 192. Reprinted by permission of Harcourt Education.

### Three Examples of Transduction

We will now discuss three examples of transduction: The six modes involved are artefacts/3D objects, still image, writing, action, moving image, speech. The three instances involve transduction from artefact to image and writing, from action to image and writing, and from action to moving image and speech. We begin with transduction from artefact to image and writing.

#### From Artefact to Image and Writing

In discussing our examples (see Figure 1) we draw attention to (some aspects of) significant changes, focusing on what may be gained and what may be lost when moving from artefact to image.

When representing an artefact such as a protractor as an image, there are losses in *specificity*. Certain dimensional and tactile aspects, for instance,

cannot be expressed in image, they can only be simulated via perspectival resources. The material substance, its three-dimensional shape and, in many cases, the actual size of the protractor cannot feature in the image. While there is a loss in specificity there is a gain in *generality*: The image depicts a “prototype,” not an instance, that is, an “ideal” protractor is shown, not one that is scratchy, used, or odd in some way. Epistemologically there is no commitment that protractors have to be like this. Compared to the 3D object, the image affords a level of generality and idealization apt for the didactic practice involved, a representation that is apt also for the curricular entity that is being constructed. When the artefact is represented in writing there are also losses in specificity, though differently and maybe even more so than with image. Writing does not specify, for instance, whether the centre of the protractor is open, as in the image, or closed, or which colors are used to inscribe marks on it. It affords a yet higher level of generality than that afforded by image.

Another shift occurs in the *arrangement* of the constituents of image and writing. In both the image and in the writing, different entities can be identified. In writing, these appear as lexical entities (e.g., protractor, line) placed in syntactic structures. In “Measure the angle between these lines using the protractor,” “the protractor” is in an adverbial clause of manner (i.e., “Using the protractor, measure the angle between these lines”); in that way, it appears as the means or *instrument* in a syntactic element that is subordinated to the main clause (“[You] measure the angle”) and placed last. In the written example (spatially realized) sequence is important: The activity is “announced” first, it is foregrounded (“Measure the angle”), with the means for doing so (“using the protractor”) placed last. In image, such meanings are realized through structures based on spatial relations of proximity, adjacency, and simultaneity. In the image in Figure 1, lines are superimposed onto the protractor (something quite impossible with the original artefact) and an image of the angle qua geometrical entity is “abstracted” away and shown separately.

There are varied relations between writing and image in this representation. In writing there is the “heading” just discussed; there are commands (as imperatives) in captions attached to the main image by lines: “Read off the angle,” “Use the inner scale for anticlockwise angles,” and so on. There is also the definitional statement at the bottom: “The angle between two lines is the amount of turn from one line to the other.” We might generalize the role of writing here—beyond the statements already made—in this way: Image is used to present the core of the information—the protractor and

**Figure 2**  
**Excerpt From *Heinemann Mathematics, 7***

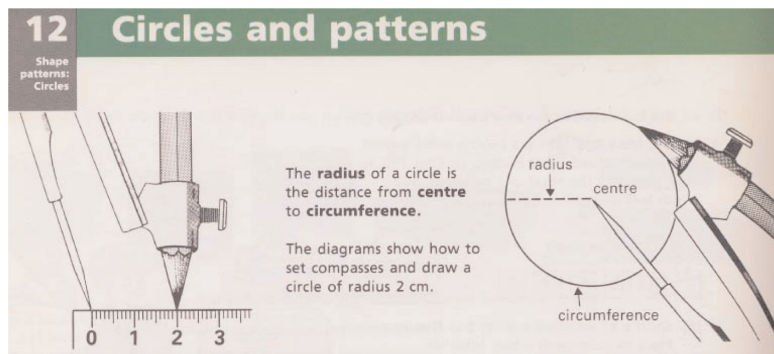

Source: Scottish Primary Mathematics Group (1991), p. 12. Reprinted by permission of Harcourt Education.

what it is like, the identity between the angle measured by the protractor and the image of the abstracted angle in the top right corner. Writing is used to present actions as commands and to provide a formal definition of angle. This might get close to seeing the functional specialization of image and writing in this aspect of the book at this time.

### From Action to Image and Writing

In the previous example writing was used to represent actions such as “Put the cross over the point of the angle,” and “Read off the angle.” Moves from action to writing also bring changes in the availability of lexical and syntactic resources. “Putting” and “reading off” are relatively “empty” as lexical items; they do not specify exactly what the actions involved are. This may seem trivial, but actions such as gestures, shifts in gaze, body posture, face, are defining features of professional practices (cf. Goodwin, 2000). In terms of social relations represented, what is gained through writing is the expression of the social relation of *command* realized via the syntax of the imperative mood: Writing readily affords the realization of the social relation between an authority and the learner.

Different kinds of gains and losses are at issue when representing the actions involved in using an artefact—a compass—in the mode of image, as Figure 2 shows.

The move from action to image also involves loss of specificity, and again we need to ask “Specificity of what kind?” Only some of the actions involved in drawing a circle—such as placing a compass alongside a ruler, opening it out to two centimeters, placing it on a piece of paper, and so on—are represented. The image on the left shows the initial placement of the compass, the image on the right shows the completion of the drawing of the circle. In fact, actions are not represented: What is depicted are points or segments in/of the action, action “frozen” at particular points in time. In terms of an epistemological change, there is the deletion of the actor: The action of drawing a circle is suggested without showing who draws the circle. Again, using a compass becomes less personal or specific and more general. It is a move away from the empirical “real” toward theoretical abstraction. What is to be debated is whether, under what circumstances, and for what purposes that is or is not a gain.

### **From Action to Moving Image and Speech**

On the Web, moving image and speech can be used alongside or instead of writing in the transduction of artefacts and actions involved in mathematics, leading to potentially rather complex multimodal configurations. Figure 3 is a still from a “scene” on rotational transformations. The scene shows, tells and describes how to rotate an angle.

The text written below the image of the protractor is as follows.

Put pointer of compass on point ‘a’. Open out compass to length of ‘ac’. Draw a curve which passes through ‘c’. This ensures that the length of the lines in the image will be the same as in the original triangle. This makes sure that the length of ‘ac’ (the image) is the same as ‘ac’ (the original) because the size of an object doesn’t change during rotation.

In this example there are transductions from artefact to writing with effects similar to those discussed before. All these have effects on changes in specificity and generality as well as in ordering. What is different here is the use of speech for the transduction of artefact and action and the use of moving image for the transduction of action. As we noted before, speech shares certain aspects of grammar, syntax, and lexis with writing. In addition it has intensity (as loudness), pitch and pitch variation, tonal/vocal quality, silence, and other resources. In this example, tone is used in speech as a resource for foregrounding particular lexical items, whereas in the written

**Figure 3**  
**Image From lgfl.skool.co.uk, “Rotational Transformations”**

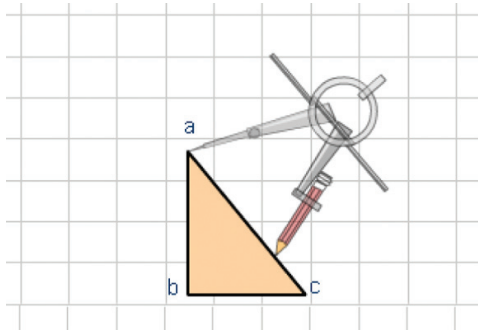

Note: Adapted from <http://lgfl.skool.co.uk/content/keystage3/maths/pc/learningsteps/RSTLC/launch.html>, August 1, 2007.

text foregrounding was realized through syntax. In the transcript below we have marked the boundaries between intonational units using a double slash, and we have italicized the items where the major pitch movement occurs, a *fall*, in this case. The element that receives the major pitch movement is thereby marked as providing *new information*. This creates a contrast of “given” and “new” information within each *information unit* (cf. Halliday, 1967).

Put pointer of *compass* // on point *a* // . Open out // compass to length of *a c* // .  
 Draw a *curve* // which passes through *c* // . This *ensures* // that the length of the  
 lines in the *image* // will be the same as in the original *triangle* // . This makes  
*sure* // that the length of *a c* // the *image* // is the same as *a c* // the *original* // .  
 Because the *size* // of an *object* // doesn't change during *rotation* // .

Comparing the written and spoken text we can see that two specific readings have been provided and with that a specific potential for learning has been created. In the first three sentences of the written text, the readers' attention is drawn to what is mentioned first—the *action* to be performed—and to the imperative mood, thus foregrounding, action as *command*. In the spoken text, the reader's attention is first drawn to the object involved in the action, the compass, and the location where it should be placed, then to the specific *kind of action* of opening—“out”—that should be made and an



indication of the extent of the movement, then to the *shape* of the inscription to be made, and so on. What ensues is a contrapuntal organization, with the mode of writing highlighting action-as-commands—*put, open out, draw*—and the mode of speech highlighting *object, location, shape*.

The paragraph has a three-part structure: Part 2, sentences 4 and 5, provide a reflection on the process just described. Part 3, sentence 6, provides a definitional statement.

This text further uses the mode of moving image. It combines the affordances of still image, spatial organization, with temporal organization: It unfolds in time. That brings distinct increases in semiotic resources. Elements can now appear and disappear, and through that, movement can be suggested. In the scene that we are looking at here, the first element to appear is the triangle. Then the compass appears, placed with its pointer at ‘a.’ Then two movements take place: the “opening out” of the compass and the inscription of a curve. Then the compass disappears again. As such, the moving image represents the demonstration of how to use a compass rather differently from the written and spoken text. For instance, it is *specific* about what “opening out” and “drawing a curve” entails. “Drawing a curve” is displayed as a movement of the compass whereby one of its legs retains its position and the other leg, which leaves a trace, makes a gentle, clockwise turn.

The examples show that as we transduct from artefact to a complex of image, writing, speech, and moving image, quite different resources become available for use: resources of lexis or of depiction, with implications for generality and specificity, and syntactic resources with implications for the arrangement of constituents as well as for the social relations of maker of message and “reader”—the relation of command. So for the designer of the learning resource the question becomes one of aptness of the level of specificity-generality and arrangement for the specific occasion. There are also implications for pedagogy: In one mode commands are given, in another actors can be backgrounded; in one mode reading paths are set by the learner, in another by the designer. That in turn will lead to design decisions about use of modes. It also strongly sets the “ground” for engagement and learning.

## **Recontextualization: Changing Social Sites**

The move from one medium to another has social consequences in changing the possibilities for production: Readers of a book cannot readily alter the text they read—other than in their inner remaking. But inner

remaking does not become effective in the social world until it has some outer realization. Readers of a text on the screen can (usually) alter that text along the lines of their interest. In other words, the social potentials of different media in effect mean that the change from one medium to another brings about a change from one social context to another. This makes Bernstein's (1996) notion of *recontextualization* highly suitable for our purposes: Whatever the semiotic—modal and/or medial—change, it entails a change of social context. Of course changes in social context themselves bring with them changes in the semiotic materialization of meaning. Bernstein had developed the concept of recontextualization in order to describe how “discourses” that originate in one social site—he uses the example of carpentry—are reshaped so as to fit with the social givens of the new site, the school, in the school subject “woodwork.” Whatever the school subject, discourses produced in formal and informal sites outside school are transformed along the lines of the social organization of the new site in that process of recontextualization. Discourses are moved from the originating site of production to a pedagogic site.

Sites can be defined along the lines of the social roles of the participants/sign makers typically involved in the sites, as well as the modes, media, and genres typically used. Carpentry, for instance, is a professional practice engaged in by a community of carpenters—foreman and tradesmen/workers—who work with particular materials, producing objects for another social group, their clients. We can, if we wish, give a semiotic description to this: Carpenters as sign makers use particular materials-as-media (certain kinds of timber), modes (e.g., drawing) in social frames specific to their domain (e.g., shaping timber, assembling objects-as-signs, dismantling). When carpentry is recontextualized to the school, it used to become (in England) the school subject woodwork. Now the participant roles had been student and teacher—not foreman and tradesman/worker. Its sign makers are students and teacher; its material media are still timber; though now there are textbooks, the modes are more frequently image and writing than timber-as-mode and (some of) its genres are demonstration, exercise, examination. The sign-objects produced are very rarely for a client. When the medium of carpentry is not the textbook but the Web, then recontextualization has gone further still and potential modes now include moving image, speech, and writing.

Bernstein's concept of *pedagogic discourse* is a composite of *instructional discourse* (for us, here, broadly, the [content of] a school subject) and *regulative discourse* (for us, here, broadly, the social relations underlying a specific pedagogy). So when Bernstein writes that “pedagogic discourse

**Figure 4**  
**Excerpt From *Impact Maths IG***

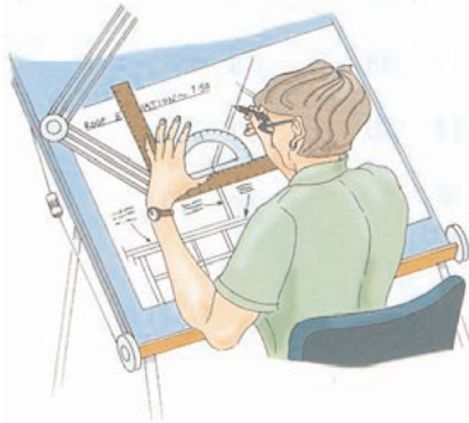

Source: Cole et al. (1999), p. 195. Reprinted by permission of Harcourt Education.

cannot be identified with the discourses it transmits. . . . It is the principle by which other discourses are appropriated and brought into a special relationship with each other, for the purpose of their selective transmission and acquisition” (Bernstein, 1996, p. 46), we agree with the latter part of that statement. As they form one part of the legitimization of the school subject, the discourses that are transmitted have to be acknowledged in the pedagogic site (see Figure 4) and their transformations in representation thoroughly understood.

Recontextualization is, literally, moving *meaning material* from one context with its social organization of participants and its modal ensembles to another, with its different social organization and modal ensembles. Meaning material always has a semiotic realization, so recontextualization involves the re-presentation of the meaning materials in a manner apt for the new context in the light of the available modal resources. Pedagogically, recontextualization involves the moving of curricular texts in line with the pedagogic features of the environment of recontextualization.

We see four rhetorical/semiotic principles operating in the process of recontextualisation: selection, arrangement, foregrounding and social repositioning. First, *selection*: What is being recontextualized is meaning

material. Not everything in the originating context may be relevant in the new context. Hence there is *selection of meaning materials*. Further, the modal resources of the new context may be different from those of the original one, and the modal ensembles needed for the audience of the new context may require *selection of modes* according to these needs. So meaning materials are selected according to what is pedagogically relevant in the new site, and modes are selected according to what is available and apt for the new site. Selection thus refers to the inevitable and motivated partiality of every representation: What is represented is guided by a complex rhetorical decision. What are the rhetor's interests? What is best for the audience in the new environment? How is the meaning material most aptly represented and what modal resources are available in the new environment?

Second, *arrangement*: In the process of recontextualization a design decision also has to be made about the arrangement of the meaning materials. In what order will they be re-presented, and what kind of semiotic arrangement will be used in their representation? At one level this is an epistemological and pedagogic-didactic decision: What epistemological frame is best for this audience and this purpose, and in what order is it best to present the curricular entities to learners? At a semiotic level this becomes a question of genres—experiment, demonstration, joint construction—but also a question of *layout*: Arrangement is different on the worksheet than in the scientific report or in the acting out of a play, and so on. The elements are ordered, that is, a temporal or spatial order—a *reading path*—is created, an order produced by the designer, in which the learner is expected to engage with the selected elements in the order provided. Of course, a designer may wish to leave the ordering as much as possible to the user.

Third, *foregrounding*: Features of the social environment shape rhetorical/representational decisions. What may be most significant in the originating environment may not be so in the environment of recontextualization. Similarly, modes that may be preferred in the first environment may not be preferred in the second; indeed they may not be available there. Given this, *foregrounding*, the assigning of salience in the context of particular social relations, becomes a principle both at the level of meaning and at the level of representation. Pedagogically, status is accorded to those elements regarded as particularly significant: Some elements are foregrounded and others are backgrounded.

Fourth, *social relations* exist, and are (re-)constructed between teacher and students, between them and the designers of the resource and between them and those who are represented (e.g., the architect in Figure 4). This

## Figure 5 Excerpt From *General Science, Part III*

CHAPTER XVIII  
**ANIMAL NUTRITION: NUTRITION IN THE MAMMAL**

**Introduction**—In the Biology section of Part II we studied the structure of some simple animals and plants, and their life processes, i.e. how they obtain and use food, how they move, respire, excrete, and reproduce. In the present section we shall consider the structure and life processes of some higher animals and plants.

**How Food is Used**—We have already studied the chief food-stuffs (p. 156). They are the useful constituents of various substances used as food.

Food is used for two purposes within the body of an organism. It supplies *energy*, including *heat*, and it supplies substances which the living organism builds up into *protoplasm*. An organism needs energy because its active tissues expend energy. Some food-stuffs supply this energy. Active tissues also "wear away" and must be replaced. Growing organisms make additional tissue. New tissue, whether to replace waste or for growth, is made from certain food-stuffs which are built up into protoplasm.

*Carbohydrates* (p. 156) are the main source of energy. *Fats* (p. 158) supply heat. *Proteins* (p. 157), *salts*, and *water* are used in making protoplasm. **Respiration** is the process by which food sets free energy in the body of an organism. This will be studied in the next chapter. **Nutrition** includes the intake of food, and all the changes it undergoes in being converted into protoplasm. In this chapter we shall study the nutrition of those higher animals which are classed as

**Mammals**—A Mammal is a backboneed animal (*Vertebrate*). Its young are born alive; they do not "hatch" from eggs. They are suckled by the mother, who produces milk for this purpose. The Mammal has two pairs of limbs, each with (usually) five digits, and its body is more or less clothed with hair.

*Animal Nutrition: Nutrition in Mammal* 161

**Digestion** is the first stage of nutrition. It takes place in the *alimentary canal*. We shall now consider this process in detail.

**The Alimentary Canal** (fig. 148).

Food taken in at the mouth passes into and along a tube called the *alimentary canal*, the other end of which opens at

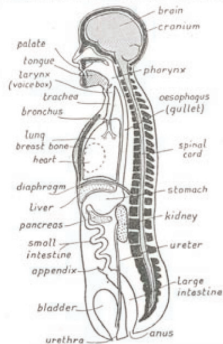

FIG. 148.—Chief internal organs of Man (simple scheme) of the hind end of the body. The opening is the anus. From the mouth onwards the parts of the alimentary canal are the "back of the mouth" (*pharynx*), the gullet (*oesophagus*), the *stomach*, and the gut (*intestine*). The whole of the canal, including the mouth cavity, is lined with a soft pink tissue

Source: Fairbrother, Nightingale, & Wyeth (1935), pp. 160-161.

notion of social relations includes but is not limited to *interactivity*, which usually refers to the learner's engagement with and transformation or transduction of the text. In recontextualization there is inevitably a *social repositioning*: A certain pedagogy emerges as the consequence of the re-contextualization.

As modes have different affordances, these four principles are realized differently in different modes. Consider the example in Figure 5. The excerpt is taken from a Science textbook published in 1935. The chapter is on the digestive system.

Comparing image and writing here shows that in both modes there is selection, arrangement, foregrounding and social (re-)positioning, but with different outcomes in each mode. In writing, for instance, the designer selected the shape of the esophagus to focus (cf. "The oesophagus is a *narrow* muscular tube," Fairbrother et al., 1935, p. 162, emphasis added), but not on its shape relative to the other organs involved in digestion. In

the image, this relative shape *has* to be shown—that is one effect of the epistemological commitment of image—but image does not show the texture of the esophagus (cf. “muscular”). In other words, image and writing are not simply copies of each other, nor is image more “simplified” than writing, as the caption of the figure suggests (cf. “Chief internal organs of Man (simple scheme)”). Rather, they each offer distinctive epistemological affordances and commitments.

As far as arrangement goes, writing constructs a reading path that is based on linearity and sequence. The reader is expected to read from top to bottom and from left to right, thus first encountering mention of the pharynx, then of the esophagus, then of the stomach, finally of the gut. The image does not impose such an order; it leaves the reading path open to the learner. Foregrounding, too, is realized in both modes, but with different effects. In writing, foregrounding is realized syntactically, by attaching meaning to what comes first, second, and last: “The oesophagus is a narrow muscular tube” (Fairbrother et al., 1935, p. 162) has a meaning different from “The narrow muscular tube is the oesophagus.” In writing, foregrounding is also realized graphically through a bold font. In image, salience is realized through, for example, size: The spinal cord seems disproportionately large. And social relations are created by allowing the learner control over the reading path in the case of image and allowing the textbook designer to set out the reading path for the learner in the case of writing.

The same principles apply to layout, as the examples in Figures 6 and 7 show.

At the level of layout, selection can be thought of as the choice of *framing devices* to employ in the placement of (complex) signs (as blocks of image or writing) to make the complete text. Figures 6 and 7 show two versions of the overall layout/text. The version in Figure 6 is the original, the version in Figure 7 is one we produced. Comparing the two shows how arrangement can be realized through layout. The original version realizes a *given-new* structure with writing as given and image as new. Salience is implied by placing one set of sign complexes first (i.e., in a left-right reading direction) and another later. Using rearrangement, we *transformed* the original to produce something closer to a *real-ideal* structure (in a semiotic culture where placement at the base of a visual frame implies “the empirical real” and placement at the top suggests an “ideal”), while retaining the sign elements of the original. Now a different arrangement is realized, with different sign complexes being foregrounded. (For *ideal-real* and *given-new* structures see Kress & van Leeuwen, 2006).

**Figure 6**  
**Excerpt From *Salters GCSE Science Y11***

**4 Digestion – the major stages**

**Animals need energy**

Animals, as well as plants, need supplies of energy for body processes. The energy which animals need comes from complex organic chemicals such as fats, proteins and carbohydrates which they get from eating plants (or other animals!). Thus, as you saw in *Balancing acts* (Y10), the sunlight captured by photosynthesis is the source of all the energy flowing through food chains and food webs.



*Sunlight is the source of all our energy.*

How animals manage to use this energy supply is the next chapter in the story.

**Food glorious food**

Perhaps the best way to see how animals deal with food is to look at how we as humans do it. Although there are differences from animal to animal, the basic process is the same for all animals.

**Digestion SS SA11**

Digestion is all about taking in large complex molecules, by eating plants and other animals, and breaking them down into smaller, soluble molecules.

These smaller molecules can be absorbed through the gut wall and into the blood stream.

It is only when these small molecules get into our blood stream, that we can use them for growth by the release of the energy that they contain.

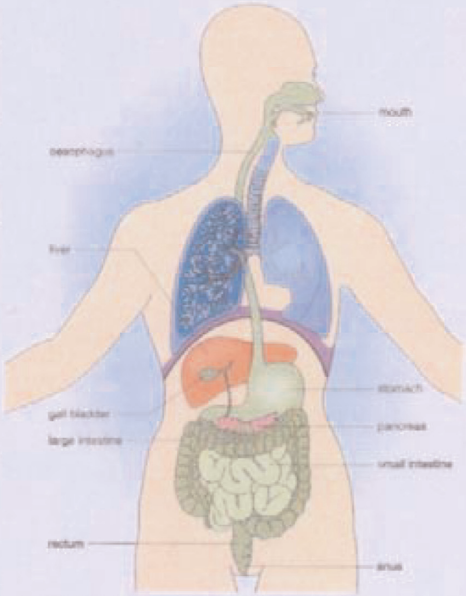

The main organs involved in digestion are shown here. This is called the digestive system.

**Staying alive**

Source: Science Education Group (2002), pp. 90-91. Reprinted by permission of Harcourt Education.



**Figure 7**  
**Rearranged Excerpt From *Salters GCSE Science Y11***

**4 Digestion – the major stages**

**Animals need energy**

Animals, as well as plants, need supplies of energy for body processes. The energy which animals need comes from complex organic chemicals such as fats, proteins and carbohydrates which they get from eating plants (or other animals). Thus, as you saw in

*Balancing acts* (Y10), the sunlight captured by photosynthesis is the source of all the energy flowing through food chains and food webs.

How animals manage to use this energy supply is the next chapter in the story.

**Food glorious food**

Perhaps the best way to see how animals deal with food is to look at how we as humans do it. Although there are differences from animal to animal, the basic process is the same for all animals.

**Digestion (SS) SA11**

Digestion is all about taking in large complex molecules, by eating plants and other animals, and breaking them down into smaller, soluble molecules. These smaller molecules can be absorbed through the gut wall and into the blood stream.

It is only when these small molecules get into our blood stream, that we can use them for growth by the release of the energy that they contain.



*Sunlight is the source of all our energy.*

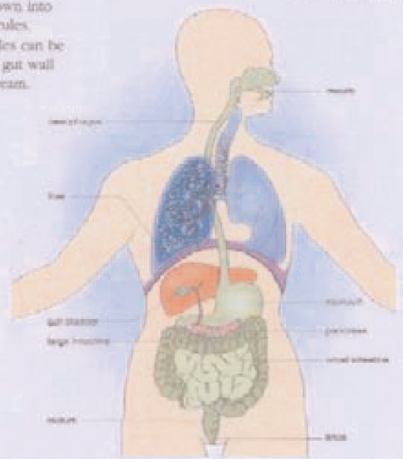

**Staying alive**

The main organs involved in digestion are shown here. This is called the digestive system.

Original Source: Science Education Group (2002), pp. 90-91. Reprinted by permission of Harcourt Education. Rearranged by the authors.



The effect of these arrangements on social relations may not be immediately recognizable in this example, but they are also realized through layout. The examples in Figures 8 and 9 show this neatly. They are different versions of the “same” textbook, used for different “ability tiers.” In the version for the “lower tier” (Figure 8) layout is much more “spaced out,” compared with the “dense” “higher tier” version (Figure 9). Spacing is here used as a signifier of ability. That is, this use of layout realizes an ideology of *simplicity of display* that is comparable to what is often said about sans serif fonts: That is, providing less “information” is seen as apt for those regarded to have a lesser capacity to process information.

The same principles also apply to moving image and speech, two modes that are at the disposal of the school Web maker. Both modes share certain resources with their graphic counterparts, image and writing, respectively. In terms of resources, what differentiates moving image from image is movement and what differentiates speech from writing are the different affordances of sound and graphic display. Moving image uses selection not just in the ways that image does, but also in anticipation of the constraints of time in moving image as compared to a still image. That is, moving image is selective in relation to *pace*; the movement of molecules, for instance, has to be slowed down to become visible. Speech is bound by the same constraint of time, and so both are partial at any one moment. In both modes a reading path is established by the sequential unfolding of the semiotic material in (real) time. In moving image, foregrounding can be realized through, for example, lighting (up), in speech, through intonation. In moving image social relations are created through forms of interactivity, for instance, the learner is given control over arrangement, is asked to drag elements in or to tick the right box. That is an affordance of image representation. In speech, social relations/positioning can be realized, for example, through the given-new informational structure, as well as through voice and accent.

## **Outlook: Writing, Representation, Gains, and Losses**

We allow ourselves to conclude with a brief programmatic assessment of issues, directions, and likely developments that follow from our approach.

We regard the framework that we have put forward as a general one; we see its potential as leading to the possibility of an inclusive rhetorical/semiotic framework. We intend to take it toward the articulation of a set of principles of the rhetoric of multimodal communication, in all settings, with any form of technology and all forms of media(tion), in any social environment. In

**Figure 8**  
**Excerpt From *Catalyst. A Framework for Success, II: Green***

## A4 Total breakdown

### Different sized particles

Each nutrient in our food is made up of particles. Carbohydrates, fats and proteins are all made of large particles. Vitamins and minerals are made of small ones. These particles are called **molecules**. You will learn more about molecules in Unit E Atoms and molecules.

The big molecules in carbohydrates, fats and proteins must be broken down into smaller ones before our bodies can use them. This is called **digestion**.

Digestion happens bit by bit as the food moves through your body.

### The long journey

When you chew up and swallow your food, it begins its journey through a long tube from the mouth to the anus. The tube is called the **gut** and it is nine metres long.

The **digestive system** is all the organs that take part in digestion. They are shown in this diagram.

**a** Look at the diagram. Name the part of the gut that links your mouth with your stomach.

### Breaking it down

As your food goes through the gut it is broken down into smaller molecules by chemicals called **enzymes**. These are added to the food in the mouth, stomach and small intestine.

Enzymes make the digestion of food happen more quickly. Without enzymes it could take a few days instead of a few hours to break down some foods.

**b** What are enzymes?

**c** Why are enzymes important in digestion?

Each enzyme helps break down a different type of nutrient. Some break down carbohydrates, some break down proteins and others break down fats.

**Learn about:**

- The digestive system
- Enzymes

**Do you remember?**

All matter is made of tiny particles we cannot see.

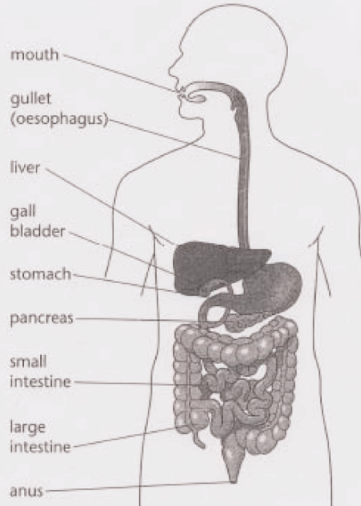

Source: Chapman (2003a), p. 8. Reprinted by permission of Harcourt Education.

**Figure 9**  
**Excerpt From *Catalyst. A Framework for Success, II: Red***

## A4 Total breakdown

### Different sized particles

Each nutrient in our food is made up of particles. Carbohydrates, fats and proteins are all made of large particles. Vitamins and minerals are made of small ones. These particles are called molecules. You will learn more about molecules in Unit E Atoms and molecules.

### The long journey

When you chew up and swallow your food, it begins its journey through a long tube from the mouth to the anus. The tube is called the gut and it is nine metres long.

Food contains nutrients. Carbohydrates, fats and proteins are all large molecules. To get these nutrients into our bodies, these large molecules must be broken down into smaller molecules. This is a **chemical process** called **digestion**.

The **digestive system** includes all the organs that take part in digestion. They are shown in the diagram on the right.

The first part of the gut is called the **gullet or oesophagus**.

In the **stomach** the food is churned up for a while by its muscular walls. After a few hours the food has become a runny liquid. This leaves the stomach and enters a long tube called the **small intestine**.

As the food passes through the digestive system it is mixed with **digestive juices** that help to break down the different nutrients.

### Breaking it down

The digestive juices contain chemicals called **enzymes**. These help to break the larger molecules into smaller molecules. Enzymes make the digestion of food happen more quickly. Enzymes for digesting food are found in the mouth, stomach and small intestine.

**ⓐ Why do you think it is important for food to be digested quickly?**

Each enzyme speeds up the breakdown of a different type of nutrient. Some break down carbohydrates, some break down proteins and others break down fats.

**Learn about:**

- The digestive system
- Enzymes

**Do you remember?**

All matter is made of tiny particles we cannot see.

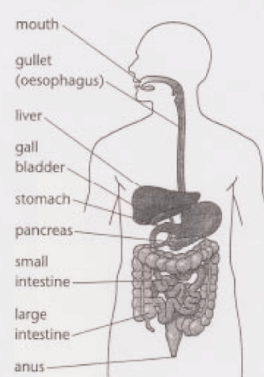

**Did you know?**

Some washing powders are described as 'biological', and others are 'non-biological'. **Biological washing powders** contain enzymes that help to clean dirty clothes. They break down stains caused by proteins in foods such as egg or gravy.

getting smaller →

starch (carbohydrate) → glucose

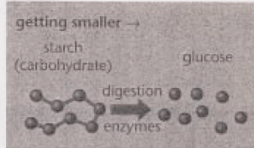

getting smaller →

protein → amino acids

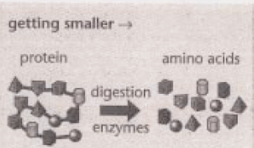

getting smaller →

fat → glycerol and fatty acids

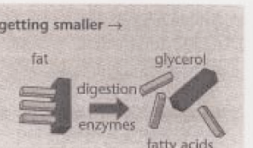

Source: Chapman (2003b), p. 8. Reprinted by permission of Harcourt Education.

the context of the issue of this journal we have attempted to indicate implications for writing within environments of multimodal representation and the likely impacts of contemporary technologies for communication.

We have exemplified the approach with issues and materials in educational contexts, our present professional environment. We believe that it provides a framework in which urgent questions of pedagogic environments—whether of teaching or of learning, formal or informal—can be addressed within an encompassing theory, allowing some of the most urgent contemporary problems to be addressed. Among these we count issues such as the effect of (features of) learning environments on potentials and possibilities of learning, the question of multimodal representations of knowledge and learning, similarly, the pressing issue of the development of apt forms of assessment for representations in different modes, treated as signs of learning. The approach provides an integration of rhetorical and pedagogic issues and questions, sensitive to environments and conditions of learning, to assessment and evaluation. Practically, it should lead to the articulation of principles applicable in the development of learning materials and environments.

On a semiotic/representational level, the approach provides means for understanding functional issues in multimodal representation, both in production and analysis, such as functional load, functional specialization, functional differentiation, functional (re-)distribution. It provides an account of the relations between social conditions and the take up of potentials of modal and medial affordances, or an explanation of unused affordances of modes and media, which may not be apparent to sign makers.

Socially, culturally, and politically this approach should make it possible to conduct debates on likely impacts of modal choices, of modal changes and modal selection that are better founded theoretically than is the present level of debate around ideologies of simplicity, ability, and the regular panics around “dumbing down” of culture in general.

In brief, we see implications at the most general level of theory of representation as well as in relation to specific disciplinary and professional issues, ranging from general to entirely practical ones.

## References

- Baker, C. D., & Freebody, P. (1989). Talk around text: constructions of textual and teacher authority in classroom discourse. In S. de Castell, A. Luke & C. Luke (Eds.), *Language, authority and criticism: Readings on the school textbook* (pp. 263-283). London: Falmer Press.
- Bernstein, B. (1996). *Pedagogy, symbolic control and identity. Theory, research, critique*. London: Taylor and Francis.

- Chapman, C. (2003a). *Catalyst. A framework for success. II. Green*. Oxford, England: Heinemann.
- Chapman, C. (2003b). *Catalyst. A framework for success. II. Red*. Oxford, England: Heinemann.
- Cole, G., Fraser, B., Grantham, K., Hughes, P., Kent, D., et al. (1999). *Impact maths 1G*. Oxford, England: Heinemann.
- Dimopoulos, K., Koulaides, V., & Sklaveniti, S. (2003). Towards an analysis of visual images in school science textbooks and press articles about science and technology. *Research in Science Education*, 33(2), 189-216.
- Fairbrother, F., Nightingale, E., & Wyeth, F. J. (1935). *General science. Part III*. London: G. Bell and Sons.
- Goffman, E. (1986). *Frame analysis. An essay on the organization of experience*. Boston: Northeastern University Press.
- Goodwin, C. (2000). Action and embodiment within situated human interaction. *Journal of Pragmatics*, 32, 1489-1522.
- Halliday, M. A. K. (1967). *Intonation and grammar in British English*. The Hague: Mouton.
- Halliday, M. A. K. (1994). *An introduction to functional grammar*. London: Edward Arnold.
- Hodge, R., & Kress, G. (1988). *Social semiotics*. Cambridge, England: Polity Press.
- Jewitt, C. (2003). Computer-mediated learning: The multimodal construction of mathematical entities on screen. In C. Jewitt & G. Kress (Eds.), *Multimodal literacy* (pp. 34-55). New York: Peter Lang.
- Jewitt, C. (2005). *Technology, literacy, learning. A multimodal approach*. London: Routledge.
- Kaplan, N. (1995). Politexts, hypertexts, and other cultural formations in the late age of print. *Computer-Mediated Communication Magazine*, 2, 3.
- Kress, G. (2003). *Literacy in the new media age*. London: Routledge.
- Kress, G. (2005). Gains and losses: New forms of texts, knowledge and learning. *Computers and Composition*, 22, 5-22.
- Kress, G., Jewitt, C., Franks, A., Bourne, J., Hardcastle, J., Jones, K., & Reid, J. (2005). *English in urban classrooms: A multimodal perspective on teaching and learning*. London: RoutledgeFarmer.
- Kress, G., Jewitt, C., Ogborn, J., & Tsatsarelis, C. (2001). *Multimodal teaching and learning. The rhetorics of the science classroom*. London: Continuum.
- Kress, G., & van Leeuwen, T. (2001). *Multimodal discourse. The modes and media of contemporary communication*. London: Edward Arnold.
- Kress, G., & van Leeuwen, T. (2006). *Reading images. The grammar of visual design*. London: Routledge.
- Lemke, J. (2000). Multimedia demands of the scientific curriculum. *Linguistics and Education*, 10(3), 247-271.
- Martinez Pena, B., & Gil Quilez, M. J. (2001). The importance of images in astronomy education. *International Journal of Science in Education*, 23(11), 1125-1135.
- Maybin, J., & Moss, G. (1993). Talk about texts: reading as a social event. *Journal of Research in Reading*, 16(2), 138-147.
- Myers, G. (1990). *Writing biology: Texts in the social construction of science*. Madison, WI: University of Wisconsin Press.
- O'Halloran, K. (2005). *Mathematical discourse: Language, symbolism and visual images*. London: Continuum.
- Pintó, R. (Ed.). (2002). Visual language in science education [Special issue]. *International Journal of Scientific Education*, 24(3).
- Postman, N. (1993). *Technopoly: The surrender of culture to technology*. New York: Vintage Books.

- Pozzer, L. L., & Roth, W. M. (2003). Prevalence, function, and structure of photographs in high school biology. *Journal of Research in Science Teaching*, 40(10), 1089-1114.
- Roth, W. M., Bowen, M., & McGinn, M. K. (1999). Differences in graph-related practices between high school biology textbooks and scientific ecology journals. *Journal of Research in Science Teaching*, 36(9), 977-1019.
- Science Education Group. (2002). *Salter's GCSE science Y11*. Oxford, England: Heinemann.
- Scottish Primary Mathematics Group. (1991). *Heinemann mathematics 7. Textbook*. Oxford, England: Heinemann.
- Tuman, M. (1992). *Word perfect: Literacy in the computer age*. Pittsburgh, PA: Pittsburgh University Press.
- Unsworth, L. (2001). *Teaching multiliteracies across the curriculum. Changing contexts of text and image in classroom practice*. Buckingham, England: Open University Press.

**Jeff Bezemer** received his master's degree in Studies in Language and Culture and his PhD in Education from Tilburg University, Netherlands. He is now Research Officer at the Institute of Education, Centre for Multimodal Research. His research is focused on graphic representation and face-to-face communication in educational settings. Recent publications, including articles in *Linguistics and Education*, *L1 Educational Studies in Languages and Literature*, and *Encyclopedia of Language and Education*, also deal with multilingualism in immigrant settings.

**Gunther Kress** is professor of Semiotics and Education at the Institute of Education, University of London. He is interested in questions of meaning and its semiotic realizations in interrelation with social and cultural organization. In his professional location, his focus is on learning and on the material shape of curricula and forms of pedagogy in a globalizing world. Among his recent books are *Multimodal Discourse*, *Before Writing: Rethinking Paths to Literacy*, *Literacy in the New Media Age*, and *Reading Images: The Grammar of Visual Design*.